



THE POWER OF GREEN

BiG Pack

Big Balers





BiG Pack

Big Balers

- **HighSpeed:** 20% higher throughputs while maintaining the same density
- **HDP:** Higher bale density – up to 25% heavier bales than from the BiG Pack 1290
- **HDP II:** Up to 70% higher throughput or up to 10% higher bale densities than from the HDP HighSpeed
- Chamber sizes from 80 x 70 cm to 120 x 130 cm
- **VFS** along with electronic baling pressure control for even bale densities



- **X-Cut** and **VariCut** cutting systems and **PreChop** for short cutting lengths
- Well-proven KRONE knotters for high-density and well-shaped bales
- **MultiBale system** packs up to nine small bales in one single big pack
- **BaleCollect** accumulator runs behind the baler collecting the finished bales as they leave the baler for greater harvest efficiencies and reduced field traffic



One step ahead – with a KRONE BiG Pack. Whether you are making heavier, rock-hard bales with the BiG Pack HDP II or tying up to nine small bales neatly into one big bale with the MultiBale system, you'll always be ahead of the field, using first-time innovations you won't find anywhere else.

BiG Pack – the success range	4
The Active Pick-up	12
The cutting system	14
The VariCut cutting system	16
The PreChopper	18
The VFS Variable Filling System	20
The driveline and baling chamber	22
The knotter system	26
MultiBale	28
The operator terminals	30
BiG Pack 890/1270/1290/4 x 4	32
High-Density-Press (HDP)	34
BiG Pack 870 HDP (XC) MultiBale	36
BiG Pack 1290 HDP (XC/ VC)	38
BiG Pack 1290 HDP II	40
The BaleCollect accumulator	44
Options	46
Twine	50
Technical data	52



BiG Pack – the success range

Big baler that suit every application

- Chamber sizes from 80 x 70 cm to 120 x 130 cm
- **Active Pick-up** – the camless **EasyFlow** with powered feed roller
- VFS Variable Filling System
- The **X-Cut** and **VariCut** cutting systems and the **PreChop** system
- **MultiBale system**: Up to nine small bales in one single pack
- Automatic baling pressure control





By buying a KRONE big baler you're investing in experience and expertise in baler design. With so much experience under its belt, KRONE knows exactly what farmers need in the field and offers a complete range of balers with different chamber dimensions. The Variable Filling System, the unique MultiBale system and the camless EasyFlow pick-up with mechanical-drive rotor (Active Pick-up) are the stand-out features that have won international recognition and underpin the great success of the KRONE BiG Pack.

The BiG Pack model range (by chamber size)

BiG Pack 870 HDP MultiBale HighSpeed BiG Pack 870 HDP MultiBale XC HighSpeed	80 x 70 cm up to 9 small bales go into one big bale	
BiG Pack 890 HighSpeed BiG Pack 890 XC HighSpeed	80 x 90 cm	
BiG Pack 1270 HighSpeed BiG Pack 1270 XC HighSpeed BiG Pack 1270 VC HighSpeed	120 x 70 cm	
BiG Pack 1270 MultiBale HighSpeed BiG Pack 1270 MultiBale XC HighSpeed BiG Pack 1270 MultiBale VC HighSpeed	120 x 70 cm up to 9 small bales go into one big bale	



The BiG Pack model range (by chamber size)

BiG Pack 1290 HighSpeed BiG Pack 1290 XC HighSpeed	120 x 90 cm	
BiG Pack 1290 HDP HighSpeed BiG Pack 1290 HDP XC HighSpeed BiG Pack 1290 HDP VC HighSpeed	120 x 90 cm	
BiG Pack 1290 HDP II BiG Pack 1290 HDP II XC	120 x 90 cm	
BiG Pack 4x4 HighSpeed BiG Pack 4x4 XC HighSpeed	120 x 130 cm	



BiG Pack

The success story



1993

The BiG Pack is born – KRONE builds its first big baler ...



2003

KRONE presents the MultiBale system – the first baler on the market to tie big bales as well as up to nine small bales in one big pack.



2006

PreChop – The integrated pre-chopping system refines the straw harvest and opens up new opportunities for square bales.



1999

KRONE launches the VFS Variable Filling System. The double knotter is now available for many BiG Pack models.



2005

The BiG Pack 1290 HDP is launched and has had a significant impact on worldwide straw haulage ever since.



2013

The BiG Pack HDP II rips up the record book. KRONE launches a completely new big baler that scales new heights in terms of throughput and density.



2016

KRONE's short straw cutting range gets a boost with the 51-blade Vari-Cut (VC) cutting system.



2011

Generation High-Speed overtakes the big baler market – with up to 20% more throughput than their predecessors while maintaining the same density.



2015

KRONE combines the properties of three BiG Packs in one. The BiG Pack 870 HDP XC MultiBale HighSpeed has a high-density press and can produce easy-to-handle bales – all in an extremely handy bale size.



2017

The KRONE BaleCollect is an effective tool in optimising straw harvesting. This bale collector can collect up to three bales in the field. Thanks to its telescoping drawbar BaleCollect tracks behind the baler like trailer on public roads.



BiG Pack – The success range



BiG Pack 890 (XC) HighSpeed

With four double knotters and a chamber measuring 80 cm in width and 90 cm in height, this machine has proved its worth time and again – not just in straw but also in heavy, wet silage.



BiG Pack 1270 (XC/VC) HighSpeed

The 70 cm high x 120 cm wide chamber on this machine makes it truly versatile. Six single or double knotters produce firm and uniform bales in straw, hay and silage.



BiG Pack 1270 (XC/VC) MultiBale HighSpeed

This version enables you to pack up to nine small packs in one big bale. Big bales can be cleared quickly from the field, and the smaller packs are easy to distribute later on.



BiG Pack 1290 (XC) HighSpeed

These solid 1.20 m wide and 90 cm high bales are popular with farmers the world over. With its massive bale dimensions, this machine is mainly in demand for straw and hay, but it also handles silage successfully in some countries.



BiG Pack 4x4 (XC) HighSpeed

With a chamber height of 130 cm, you get fewer bales per hectare and save time and money on labour too – because the field is cleared fast. This baler is mainly used in straw and hay.



BiG Pack – the HDP range



BiG Pack 870 HDP (XC) MultiBale

The “3-in-1” machine. Boating a 80 x 70 cm chamber, this model produces the same densities as a BiG Pack HDP. This baler also comes with the MultiBale function that enables contractors to respond flexibly to their customers’ needs.



BiG Pack 1290 HDP (XC/VC) HighSpeed

Rock-hard bales. Because the HDP high-density baling system and the longer baling chamber deliver up to 25% heavier bales than conventional systems. And this pays for itself fast in terms of haulage.



BiG Pack 1290 HDP II (XC)

Higher density – higher forward speeds. With its eight double knotters, this baler produces up to 70% higher throughputs or up to 10% higher densities than the BiG Pack HDP HighSpeed. It also delivers a lot more power on the field, making your straw logistics more efficient.



KRONE Active Pick-up

- Cleanest sweeps: from a more effective pick-up with a powered feed roller
- Powered feed roller for superior performance even in brittle material
- Smoother running thanks to camless design
- Less wear with 68% fewer moving parts
- Maintenance-free and long-lasting

KRONE Active Pick-up – a clever combination of the tried-and-trusted camless EasyFlow Pick-up plus an additional powered feed roller. The speciality of this pick-up is the design of the galvanized scrapers, which ensure a continuous and smooth crop flow as the tines retract. EasyFlow can work 30% faster – allowing for faster forward speeds and higher throughputs.

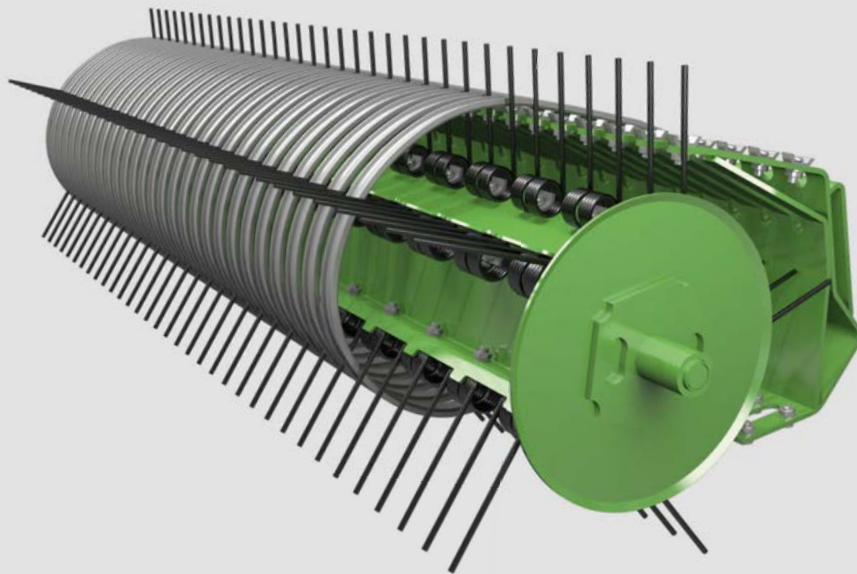

Obvious benefits

With its simple design the camless EasyFlow Pick-up has far fewer moving parts and is impressively smooth running. There's less wear, so it also costs a lot less to maintain and service.



Nothing is left behind

Working at a width of 1.95 or 2.35 m (DIN 11220) and kitted out with five rows of tines spaced 55 mm apart, the camless EasyFlow Pick-up does a clean job every time. The combination of the powered feed roller and the side-mounted augers tick all the boxes in dry, brittle material, delivering massively increased throughputs.



Gentle on the sward

The pneumatic castor wheels follow every curve and are height-adjustable without tools. The sward is even protected on curves, thanks to their excellent casting behaviour.

Depth control fitted as standard

The standard depth limiter adjusts the pick-up to work in long stubble, reducing the strain on the gauge wheels which only lift the pick-up on very uneven terrain.



Crop press roller fitted as standard

The massive crop press roller ensures a continuous flow of crop into the machine. Forage isn't pushed up in uneven swaths, and the machine operates permanently at maximum pick-up and output levels.



Easy adjustment

The crop press roller and pick-up pressures are adjusted via coil springs. The crop press roller's extremely low work height is adjusted tool-free via chains.





KRONE XCut (XC)

- 16 blades for a chamber width of 0.80 m and 26 blades for 1.20 m
- The tines have wide, hard-wearing Hardox plates
- The blade cassette lowers hydraulically and pulls out like drawer
- The blades are controlled in groups

With a full set of blades you can achieve nominal LOCs of 44 mm and 88 mm with half the number of blades in action. The feed tines are arranged chevron-style and are plated with wide Hardox steel, reducing power input and delivering the finest cuts, high throughputs and maximum longevity.



Rugged rotor, excellent cut:

The large diameter of 550 mm (720 mm on the BiG Pack HDP II) is impressive. Arranged in a V-shape, the tines pull the crop through the blades with a minimum of input power and keep the bale chamber consistently filled across the whole width.



Full throttle

The cutting and VFS rotor is driven directly off the main gearbox. Overload protection is provided by the integrated cam clutch. The HDP II is driven via a selectable poly V-belt.



Wide Hardox plates on the feed tines

The 20 mm wide Hardox plates deliver higher throughputs, a clean, scissor-like cut and greater resistance to wear – your guarantee of high-quality forage. Any mushing is eliminated.



The “pull-out drawer” principle

The XCut cutting system has two blade cassettes which lower hydraulically for convenient access. Each cassette pulls out to the side like a drawer.



Maximum protection

All blades feature individual spring protection for trouble-free operation when foreign objects are picked up. The blades conveniently push back into their working position after the foreign body has cleared.



Quick and easy

The central blade control system allows you to select different cutting lengths: 44 mm with the full set of blades and 88 mm with half of them in action.



KRONE **VariCut (VC)**

- Up to 51 blades
- Variable blade control system
- Belt drive and four-star rotor for maximum efficiency
- Produces top quality short straw
- Easy and convenient to maintain

The KRONE VariCut is an ultra-flexible multiple blade cutting system for the BiG Pack 1270 and BiG Pack 1290 HDP and comes with a choice of up to 51 blades. VariCut can produce short straw with a theoretical LOC of at least 22 mm – the ideal solution for animal feed or bedding.

Convenient overload protection

A side-mounted poly V-belt drives the pick-up and the rotor. The rotor has permanent slip control which switches it off and automatically swings the blades out of the crop flow if it becomes overloaded. To resume work, the operator first restarts the rotor and then engages the blades from the cab.

Clamped and secure

The blades are engaged hydraulically, after which the blade cassette is clamped in the frame. This takes the strain off the cassette's rolls and any vibrations that occur during cutting are safely absorbed, ensuring smooth running when the cassette is inserted and removed.

Variable blade control system

Blades can be preselected without tools in groups of 51, 26, 25, 12, or 5. The preselected group is engaged hydraulically from the cab. All cams are attached to the shaft and can be combined to form individual groups.



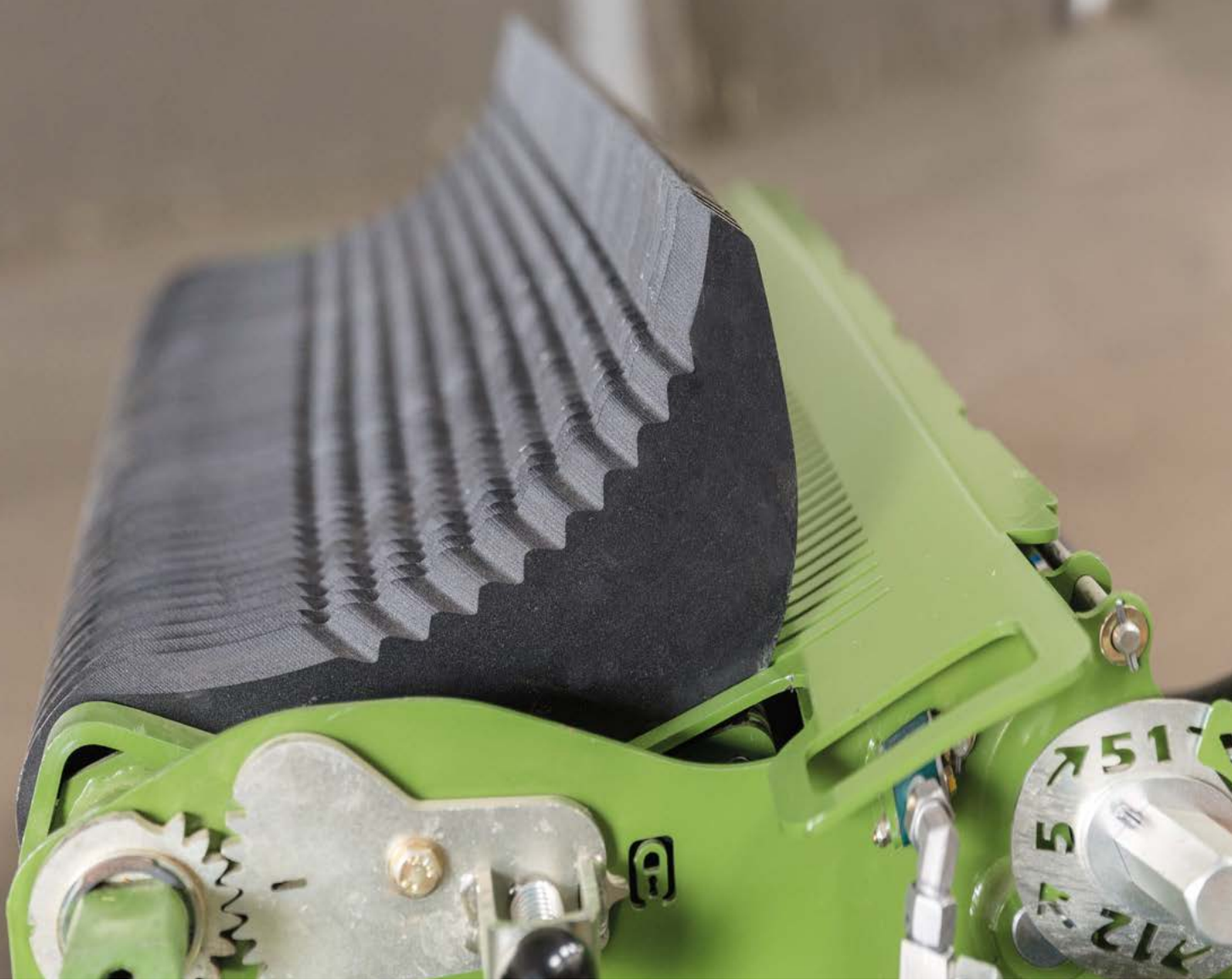

Easy to clean

A service aperture above the blades can be opened in a single action for removing deposits. The area around the blades and the individual blade protection system is kept clean with an integrated compressed air blower.



Convenient to fit and maintain

For easy removal and maintenance, the single-piece blade cassette pulls out conveniently to the side on an optional transport frame that fits on a pallet truck.



KRONE PreChop

- Short chop lengths – minimum 21 mm nominal lengths
- Adjustable LOC, two selectable counterblades
- Defibrillation effect for added liquid absorption
- Mechanical gearbox and hydraulic height control

PreChop is an integral front-mounted chopping unit on the KRONE big balers of the BiG Pack 1270 (XC/VC), 1290 (XC) und 1290 HDP (XC) series. It has 96 rotating blades and two rows of 47 counterblades that achieve a nominal LOC of 21 mm. But PreChop doesn't only chop, it also visibly defibrates the stalks.



Great features for even better productivity

Chopped and nearly dust-free straw makes perfect bedding in poultry houses and cow cubicles as well as in pig and beef cattle housing. More than that, it is used as animal feed that adds fibre to low-fibre rations but also as mulch in strawberry plantations and nutrient medium in mushroom production. The treated straw has better absorption qualities, spreads more easily in the livestock house, and prevents the slurry drains from blocking up while supporting manure mineralization.

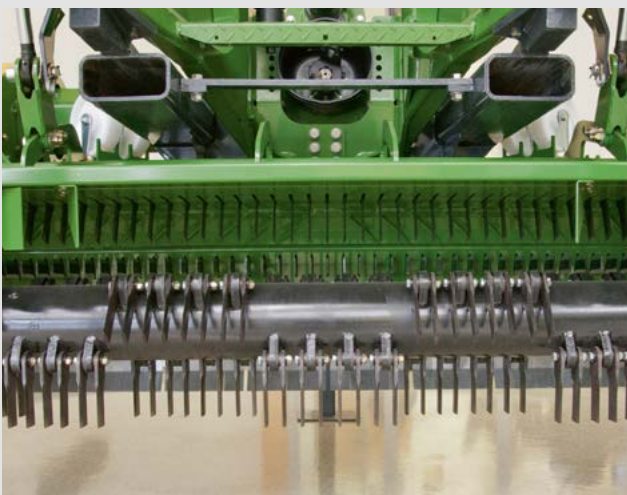

190 blades for a top quality chop

The large cutting rotor is 525 mm in diameter and features 96 pivoting blades in a helical arrangement. Rotating at 3,000 rpm, it feeds the material through two rows of counterblades with 47 rigid blades each and from here on to the BiG Pack pick-up. A turbulence generator strip between the counterblades ensures a top quality chop. The intensity of the two counterblades can be adjusted in one of five positions without tools. All blades are reversible for a long service life.



1

1. Easy to remove

If the PreChop isn't needed for an extended period, it can easily be removed. Simply remove the pins and the drive shaft and then pull the unit out to the side on its transport rolls.



2

2. Neat knots

In extremely dusty conditions, a powerful knotter cleaning system is key. The high-performance fan must be included in all orders of PreChop machines to make sure dirt and debris are removed before they actually accumulate.



3

3. Versatile Active Pick-up

When used with PreChop, the feed roller on the Active Pick-up can be stopped and switched off if necessary. The crop press roller can also be moved away. The PreChop has a high lift-out height, enabling the baler to be used without removing the PreChop.



VFS Variable Filling System

- Uniform densities courtesy of a multiphase feeding sequence
- Pre-compression in the feed chamber for maximum filling
- Stable bales even from small swaths
- Uniformly compressed bales for higher bale weights
- Automatic overload clutch for operating at full performance capacity

How the VFS system works: As the first step, the packer in combination with a feeder bar feed the material into the feed chamber where it is collected and pre-compressed. Once the feed chamber is filled to capacity, the feeder bar pushes the crop into the bale chamber. The VFS Variable Filling System from KRONE delivers rock-hard bales that keep their shape even in thin swaths and at slow forward speeds.



The two-speed baling chamber

With a KRONE BiG Pack you're geared up for any situation. In big swaths, you can operate your BiG Pack baler at full power with 1,000 rpm and 45 strokes per minute. Whereas in lighter crops you can reduce the pto speed to 800 rpm for 36 strokes and rock-solid bales plus higher fuel economy.

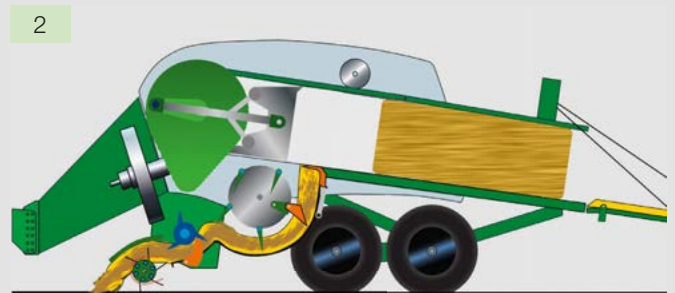
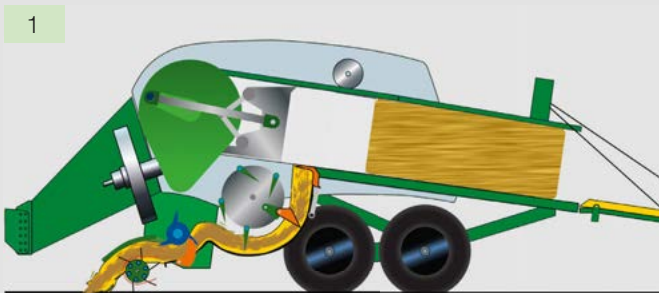



The Variable Filling System is yet another KRONE solution that is highly acclaimed by the farming world. It's another classic example of the innovative force that characterizes KRONE designs. The VFS system combines the best features of continuous feed systems with those of volume-based systems and takes big baler technology to a whole new level. VF translates into maximum efficiency at all times, irrespective of the shape and volume of the swath.

Fig. 1:

Depending on the model, the VF system operates with three or four packer rakes and one feeder rake plus one retainer. The packers run in a shared cam track, the feeder rake in a separate cam track that swings into and off path.

Fig. 2:

As long as the feeder cam track does not swing off path, the packers and the feeder continue feeding material into the feed chamber, pre-compressing it as they go. The retainer holds the material in the feed chamber, preventing it from entering the baling chamber.

Fig. 3:

When the feed chamber is filled with material, the retainer gives way to the pressure and clears the way for the material to enter the baling chamber, releasing a clutch at the same time.

Fig. 4:

The clutch swings the entire feeder cam into a different position to enable the feeder rake to feed the crop into the baling chamber. Once this cycle is completed, the retainer and feeder automatically return to their previous positions.



The driveline

- High inertia and high speeds for a quiet running system
- Power is transmitted down clutch-protected drive shafts
- No shear pins in the drive train for maximum operator comfort
- Electronic baling pressure control for even bale densities

The on-board hydraulic system with automatic baling pressure control ensures firm bale shapes and tidy edges, even in wet conditions and in different crops. Two sensors measure the current force of the plunger. A control system compares this measurement with the operator settings and the on-board hydraulic system automatically adapts the pressure exerted on the chamber walls.



Smooth start

To ensure a smooth start, all BiG Pack balers can be equipped with a hydraulic start assist system consisting of a hydro motor that accelerates the flywheel before the tractor pto is started. This start assist system is fitted as standard in the HDP II.



Quiet and comfortable

Large flywheels prevent bounce and guarantee a quiet running system. The flywheels absorb peak loads and the machine maintains a consistent speed while requiring significantly less input power.



Perfectly protected

On start-up the BiG Pack is protected by a slip clutch. In the event of an overload on the machine side an automatic cut-out clutch is activated.



Automatic mode

The operator selects a density between 0% and 100% on the control box, and the baling force control automatically adapts the pressure in the baling chamber.



Direct drive

On KRONE big balers, power is transmitted to the packer and the knotters via robust, low-maintenance drive shafts, gears and overload clutches. Buying this technology means buying into dependability and comfort.



Powerful and safe

The KRONE big balers have long plungers which support the work of the needles, a design that brings peace of mind with respect to needle operation. The BiG Pack 870 and 890 operate at 49 strokes/min, the BiG Pack 1270 and 1290 HDP and HDP II at 45 strokes/min and the BiG Pack 4 x 4 at 38 strokes/min, ensuring quiet and smooth operation.

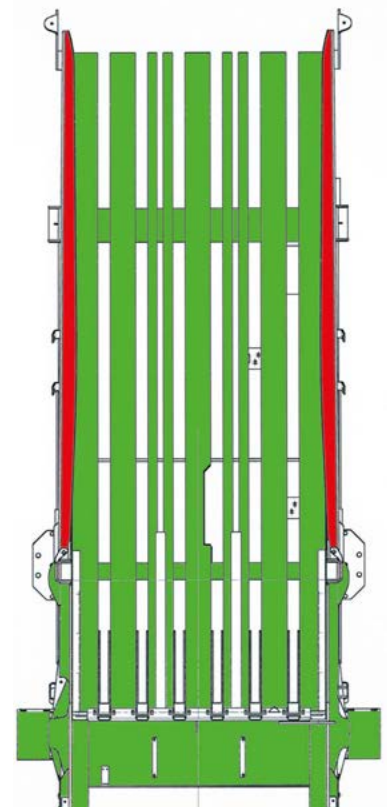

The funnel shape does the trick

For maximum bale densities, BiG Packs are equipped with long, funnel-shaped bale chambers with spring-loaded retainers on the sides and top towards the front. The rounded ends of the side walls guarantee smooth bale edges.



The **bale chamber** and **running gear**

- Massive hydraulic rams for maximum bale densities
- An electronic star wheel sensor ensures uniform bale lengths
- A 40 km/h single axle or 60 km/h tandem axles
- A rigid or caster steer boogie axle

The KRONE BiG Packs have massive hydraulic rams for highest densities. Rigid or caster-steer 60 km/h tandem axles are available to boost productivity.



Full-on power for rock-solid bales

Up to six massive rams operate the top and the side walls of the chamber. The heavy-duty yoke is designed to cope with exceptionally high loads in non-stop operation.



Consistent bale length every time

KRONE equips all BiG Packs with a star wheel that measures the bale length electronically. The star wheel is mounted centrally in the bale chamber floor.

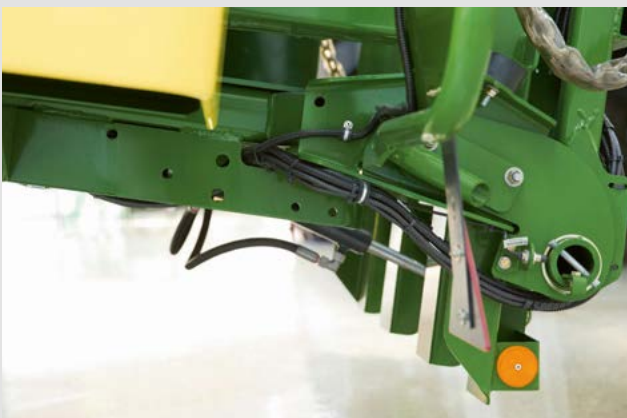

Extendable rear end

The BiG Pack features a very strong frame that also has a hitch to pull a bale for example. The BiG Pack features a very strong frame that also has a hitch to pull a bale accumulator for example.



Standard single axle on BiG Pack 890

The BiG Pack 890 is available with a single axle and large tyres (710/45-22.5) for speeds of up to 40 km/h or optional tandem axles for speeds of up to 60 km/h.



4-leaf parabolic spring suspension

Giving large travel, the spring assembly spreads the machine weight evenly between the front and rear axles – a special boon in boggy terrain.



The choice is yours

The boogie axle is available in two versions – Either as rigid or caster steer axle with locking ram to lock it in its middle position. Both versions are approved for up to 60 km/h provided they are fitted with appropriate tyres.

Fast moving on uneven terrain

With the tandem axle designed as a boogie unit, BiG Pack runs smoothly and quietly at speeds of up to 60 km/h – to the pleasure of man and machine. Rear wheel steering gives you full control in every twist and turn. Tyre scrubbing is avoided and the sward remains intact. For even greater convenience while reversing, the steering axle is moved hydraulically into mid-position and locked. The sprung boogie tandem axle unit can be fitted with large 17" to 26.5" tyres depending on the machine.





The KRONE **knotter system**

- Absolutely reliable – simple twine feeding system
- Cleaning by air
- Central lubrication provided as standard
- Long service life

The KRONE knotting system delivers a high-density and firm bale every single time. The double knotter technology on the BiG Pack 870 HDP is fitted as standard on all chambers measuring more than 70 cm in height, where it ties even high-density bales and crops that are prone to expanding into packs that hold. BiG Pack 1270 is fitted with single knotters as standard, but double knotters are available as an option.

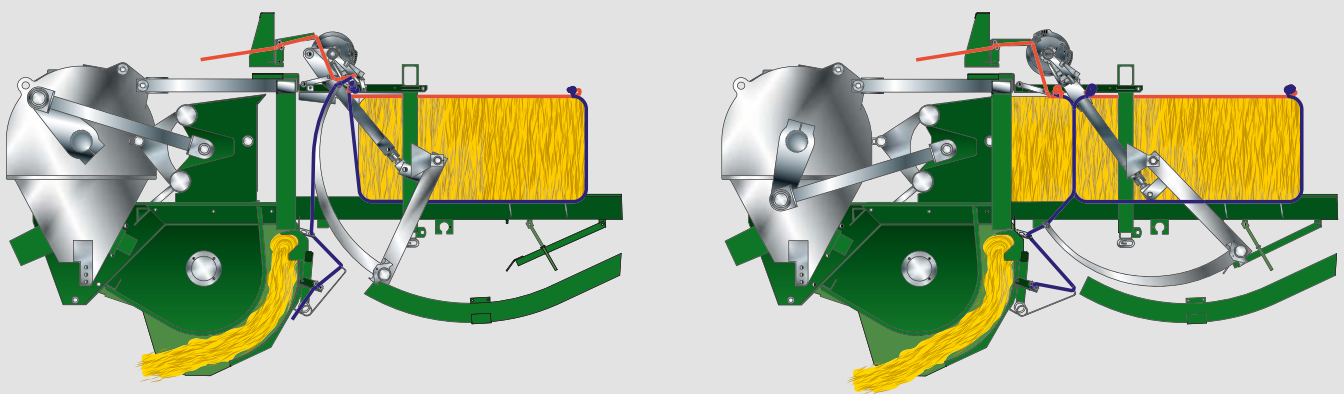

How the double knotter works

The knotter feeds an upper and a lower twine to the bale as it is being pressed and ties the twine with two knots – one at the front end of the bale (starter knot no. 1) and one at the rear end (finishing knot no. 2). The lower twine is threaded through the needle by a tensioning system that surrounds

the base and the two ends of the bale. The upper twine is supplied to the bale directly by a tensioning system and encloses the top of the bale. This system allows the machine to apply maximum baling force in any type of crop.

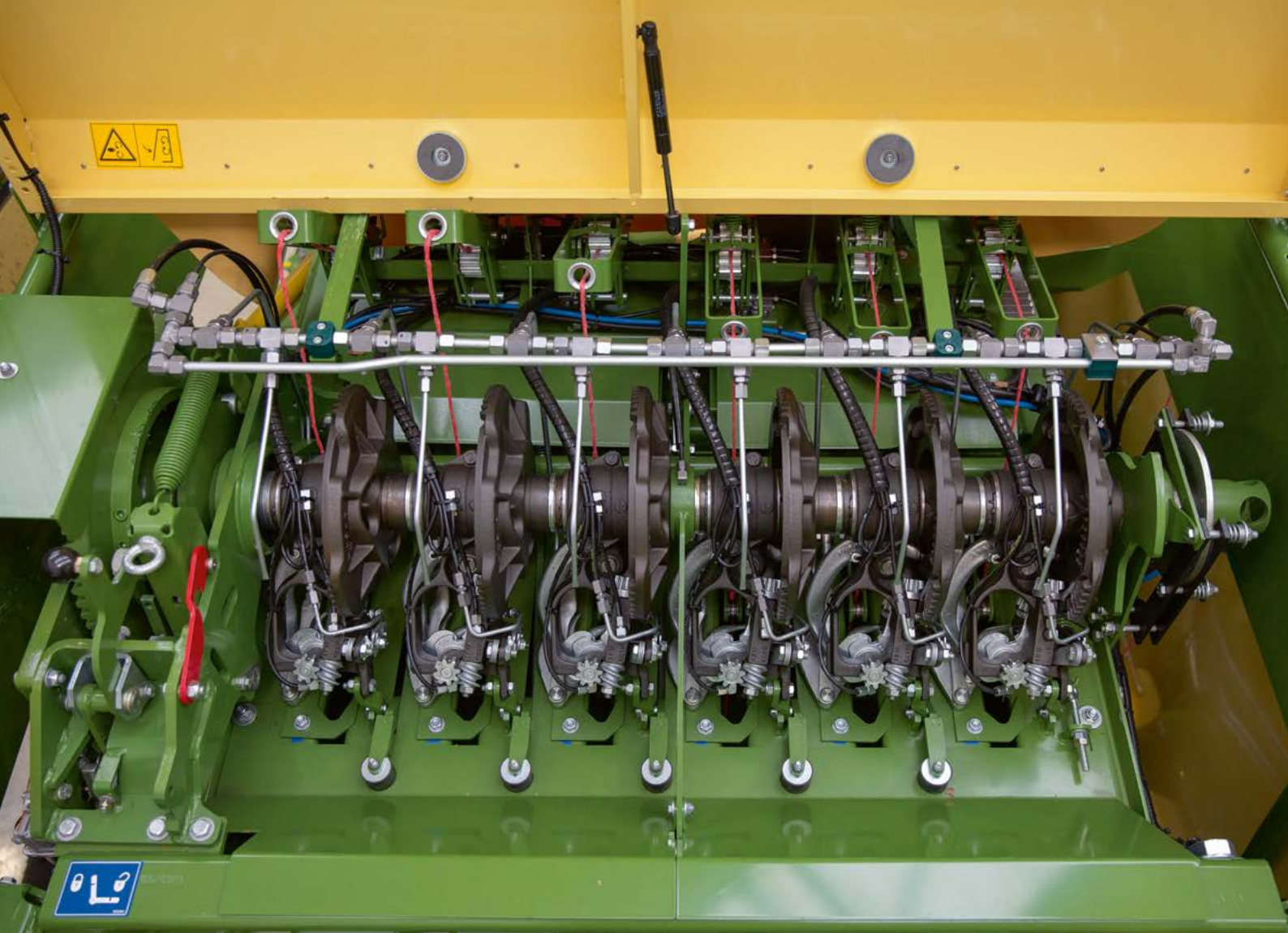

Cleaning by air

The air cleaning system guarantees ultra-reliable knotting – even in extreme conditions. The airlines clean the knotters regularly with a jet of compressed air.



On-board compressor

Not all tractors in every country feature a compressed air system. To ensure no machine has to do without compressed-air knotter cleaning, KRONE balers without air brakes are equipped with an on-board compressor.



Enough twine for knotting

With as many as 32 twine balls (11 kg each) on board (54 on the HDP II), you can bale more than 900 bales without stopping for a refill. The dust-proof twine boxes can be simply flipped up to allow access for servicing.



KRONE MultiBale

- Up to nine small bales in one single big pack
- Small bales from 0.30 to 1.35 m
- BiG performance in the field
- Small bales for easy handling in the yard

Up to nine single bales are packed in one big bale:

The award-winning KRONE MultiBale system makes bales much easier to handle. The small bales can be between 0.30 and 1.35 m in length. Naturally, you can also produce conventional big bales with lengths of up to 2.70 m.



Customers' wishes come true

The optional MultiBale system has double knotter technology and is controlled via the on-board Comfort control unit. MultiBale gets the field cleared quickly and you can supply your customers with big bales made up of small packs. The MultiBale system made its mark on the market in no time. After all, small bales are so much easier to handle in confined buildings.

From big to small

On the move, the operator sets the required number of bales on the control box in the cab, selecting the total length of the big bale and the number of small packs. The small bales are held together with two strings, whereas

the big bale has three (BiG Pack 870) or four (BiG Pack 1270). Naturally you can also produce conventional full-size single bales tied with five or six strings.

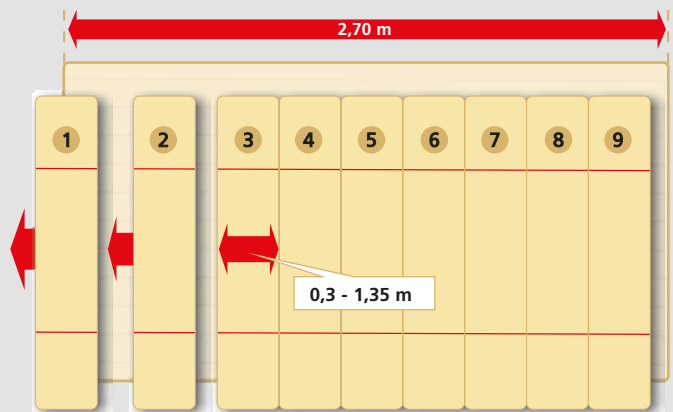



Two plus three knots on the BiG Pack 870 HDP (XC) MultiBale

Divided needle yokes

In MultiBale mode, two knotters knot the small packs and the others tie the big bale, assisted by a divided needle yoke. The two needle yokes are coupled and uncoupled by a controlled latch. The double knotters will only work when they are supplied with twine, so the other strings simply pass through underneath the knotters. The small bales are tied with two lengths of twine (1). When the bale is complete, the two yokes are automatically re-engaged so that all the knotters are now supplied with twine (2). Then the big bale is tied.

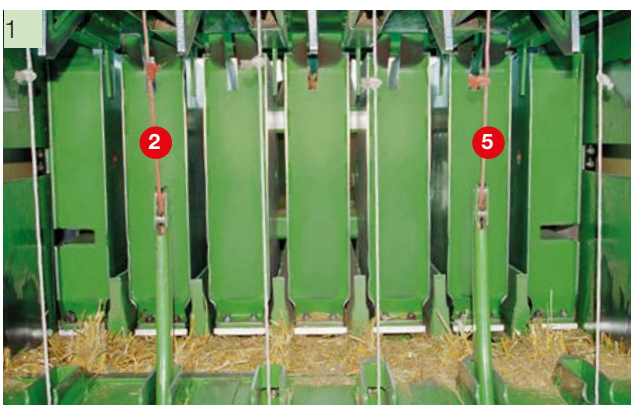

Two plus four knots on the BiG Pack 1270 (XC) MultiBale

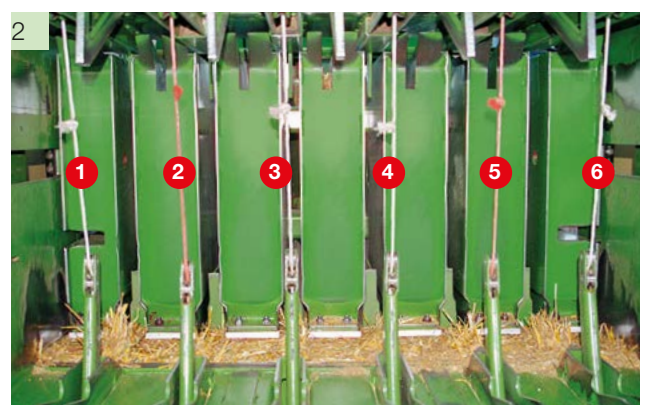



The operator terminals

- High-resolution colour touchscreens
- The control units on KRONE BiG Pack big balers are all ISOBUS-compatible.
- If the KRONE BiG Pack is hitched to an ISOBUS-compatible tractor, you can use the tractor terminal to control the baler.

Even the entry-level DS 500 from KRONE offers convenient and comprehensive control of all major functions from a colour touchscreen. The CCI 800 and CCI 1200 ISOBUS terminals take user comfort to the max, offering one screen that displays both the machine user interface and the images that are fed from camera.



The DS 500 Terminal

The compact DS 500 terminal has a 5.7" colour display screen with a clear layout for easy use. You can either operate the machine from the 12 function keys or the touchscreen and the dial control on the back of the device.



The CCI 800 Terminal

The CCI 800 ISOBUS terminal with 8" touchscreen serves as user interface and also as camera screen which feeds the images from the bale accumulator for example, offering multi-functionality that saves costs and frees cab space for uninterrupted view. Even more comfort comes from the AUX joystick that is available as an addition to the CCI 800. The individual machine functions are shown in mini-view format on the bright, high-resolution colour screen.



The CCI 1200 Terminal

The new ISOBUS-compatible CCI 1200 terminal with its 12" touch screen displays the views of two universal terminals (UT) on one screen. This allows the operator to control combinations such as a BiG Pack and a BaleCollect from one single terminal and view footage from several cameras on the same screen – a money-saving feature that provides a better all-round view from the cab. The individual machine functions are shown in mini-view format on the bright, high-resolution colour screen.



The tractor terminal

All ISOBUS-compatible KRONE machines can also be controlled from the tractor's existing ISOBUS terminal. Simply connect one single cable and enjoy your customized user interface on the terminal in the cab. Optional controls like the WTK joystick make the tractor even easier to operate, depending on the tractor specification.



BiG Pack 890 · 1270 · 1290 · 4 x 4 HighSpeed

- **BiG Pack 890 HighSpeed:** the baler for handy sized bales
- **BiG Pack 1270 HighSpeed:** single or double knotters with optional **MultiBale** function
- **BiG Pack 1290 HighSpeed:** the world's most popular bale size
- **BiG Pack 4 x 4 HighSpeed:** high throughput and the world's biggest square bales

With their different chamber dimensions and many unique features, the BiG Pack 890 (XC), 1270 (XC/VC), 1290 (XC) and 4 x 4 (XC) deliver exceptional performance in straw, hay and other crops the world over. Every BiG Pack produces consistently stable bales – from small packs to the biggest bales on the market.



BiG Pack 890 (XC) HighSpeed

At 80 x 90 cm, this machine has the smallest chamber of any of the standard range of KRONE big balers. The handy, lightweight bales it produces are perfect for smaller farms that harvest smaller quantities of straw and hay. This machine is available either with a single axle or a rigid, steered tandem axle. Also, choose between Medium and Comfort on-board electronic controls. An Active Pick-up with a 1.95 m wide powered feed roller is standard spec, and a 2.35 m wide pick-up is available as an option.



BiG Pack 1270 (XC/VC) HighSpeed

This machine produces bales measuring 120 cm wide x 70 cm high – one of the most popular bale sizes, particularly in Europe. Choose between single and double knotters. The speciality of this machine is that it is also available as a Multi-Bale version Which enables you to tie up to nine small bales in one big pack. In this case you'll need a double knotter and the on-board Comfort electronic system.



BiG Pack 1290 (XC) HighSpeed

The true all-rounder in the range. With its six double knotters and 120 cm wide x 90 cm high baling chamber, this baler produces firm, tidy bales in exactly the right size for the international market.



BiG Pack 4x4 (XC) HighSpeed

Designed to impress: this big baler has a massive baling chamber measuring 4 x 4 ft (120 x 130 cm) and produces bales up to 3.2 m in length. The BiG Pack 4x4 produces the world's biggest square bales. A flywheel weighing more than 600 kg and the powerful main gearbox press the material through the baling chamber at up to 38 strokes/minute – powerfully and gently at the same time. These massive bales are ideal for use both on the farm and in industrial applications.



High-Density Press

- Ground-breaking high-density baling technology
- Exceptionally high density and excellent handling
- Highly efficient straw logistics

These days roughly one in every 10 big balers sold worldwide is a KRONE BiG Pack 1290 HDP. And our HDP portfolio has kept on growing. Now high-density square bales are also available in a handy bale size with the BiG Pack 870 HDP MultiBale.

The HDP concept

Back in 2003, KRONE took an in-depth look at how to optimize the straw haulage chain.

The handling large amounts of straw is governed by the following aspects:

- collection and handling is time consuming
- expensive labour
- expensive logistics
- inadequate use of truck capacity
- large storage capacities needed

The only way to optimize all parameters was to increase bale weights by increasing densities.

And so the concept of the **High-Density Press** was born.



Get the field cleared fast

Harvesting a crop that yields 4 tonnes of straw per hectare and producing 500 kg bales rather than the 400 kg from a conventional big baler cuts the number of bales to be collected by two per hectare. Even though the machine uses higher quality twine – KRONE recommends the KRONE excellent HDP Strong² – twine costs drop by up to 25% courtesy of the higher baling density.



Cutting costs

The profitability and cost-effectiveness of straw baling depends to a great extent on the baling, transportation and storage costs. KRONE has the answer with the HDP system. The up to 25% higher density bales cut the production costs per tonne, increasing the profit potential of professional straw sales. A BiG Pack HDP is your guarantee of success. It's the smart way to work.



BiG Pack HDP II – simply unbeaten

KRONE has developed a completely new big baler that scales new heights in efficient straw handling. The HDP II is the undisputed market leader when it comes to baler throughput. The HDP II beats a standard HDP baler hands down when it comes to baling speed. This big baler delivers up to 70% more throughput while maintaining the same density. Getting every field cleared fast.



BiG Pack 870 HDP (XC) MultiBale HighSpeed

- 80 x 70 cm chamber for greater flexibility
- Up to 25% denser bales with **HDP technology**
- **MultiBale:** up to nine small packs in one big bale

The BiG Pack 870 HDP (XC) MultiBale HighSpeed gives you maximum flexibility. The unique and patented system ties up to 9 small individual bales into one big pack. With much fewer bales to collect and transport, MultiBale makes bale handling so much easier in the field.



Easy handling

The MultiBale system ties up to nine small individual bales together in one big pack. This makes them much easier to handle in the field, with up to 20 times fewer bales to collect and load compared with HD bales.



The “3-in-1” machine.

The BiG Pack 870 HDP (XC) MultiBale HighSpeed enables you to respond with maximum flexibility to your customers’ wants and needs. Because this baler not only produces standard bales but transport-friendly heavier HDP bales and practical MultiBales as well. The MultiBale is the new HD bale that enables you to achieve much higher throughputs with a comparable end product.



From big to small

The advantages are obvious: there are only a few big bales to collect in the field, and their size makes them very easy to stack, transport and store. The advantages are obvious: there are only a few big bales to collect in the field, and their size makes them very easy to stack, transport and store. Back in the yard, the small packs are easy to separate by hand simply by snipping through three strings.



Tailor-made for container shipping

The width of the baling chamber can be reduced by 3 cm with optional spacers for a perfect fit for the most common sea containers, even with bales containing different crops.





BiG Pack **1290 HDP (XC/VC) HighSpeed**

- Highest baling density – up to 25% higher bale weight
- Fewer bales per hectare – fields cleared faster
- Less storage space – lower freight costs

With its extended 120 x 90 cm baling chamber the KRONE BiG Pack 1290 HDP takes baling density to a whole new level. Bales produced by HDP are 25% heavier than bales from traditional big balers.



Quick payback

The BiG Pack 1290 HDP breaks new ground among big balers. The high density of the bales saves space and the uniform, sharp-edged bales are easy to stack. More

weight and less volume – that has a positive impact on handling, transport and storage costs.

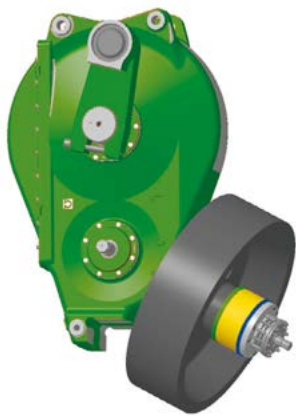

Clever twist

The combination of the huge bevel gearbox and the flywheel tipping the scales at more than 600 kg can cope with more than 940 kW/1280 hp and efficiently absorbs peak loads on the plunger during baling.



Extended bale chamber

The extended chamber bales 500 kg bales of 2.35 m in length – as demonstrated by BiG Pack 1290 HDP many times over in straw. The strengthened, funnel-shaped bale chamber, which has been extended by 80 cm, produces up to 25% denser bales.



The pressure's on

To cope with the high baling pressure, KRONE has kitted out its balers with around 2.5 tonnes more steel. The large, reinforced yoke is designed to cope with exceptionally high loads. Six hydraulic rams generate the force on the side walls, delivering rock-solid big bales.



BiG Pack **HDP II**

High-density big baler

- Up to 70% higher throughputs than the BiG Pack 1290 HDP HighSpeed
- or up to 10% higher density than the BiG Pack 1290 HDP HighSpeed
- Eight patented double knotters for exceptionally high density bales
- The twine boxes lower hydraulically for easy maintenance and refilling

Up to 70% higher throughput or up to 10% higher bale density than the BiG Pack 1290 HDP HighSpeed – these were the ambitious targets the KRONE engineers set themselves in designing the new BiG Pack HDP II. Plenty of attractive features increase the efficiency of this baler and make it more user-friendly to operate.

Big and powerful

After many years' experience with the BiG Pack 1290 HDP (High Density Press), KRONE has designed a completely new Big Brother to the highly successful BiG Pack HDP big baler, reinforcing its position as market leader in high-density baling.



Setting new standards in baling density and ground speed

Do you transport your straw over long distances? Do you have large volumes to bale with just a short time window to do it in? Would you like to make better use of your storage space? Then KRONE's engineers have designed just the machine for you. "BiG Pack HDP II" is a formula that equates to even higher baling densities at substantially higher ground speeds.



Direct drive

All the drive power on a KRONE big baler is transmitted down robust, low maintenance drive shafts, gearboxes and overload protection clutches. And not a chain or a shear pin in sight. Buying this technology means buying into dependability and comfort.

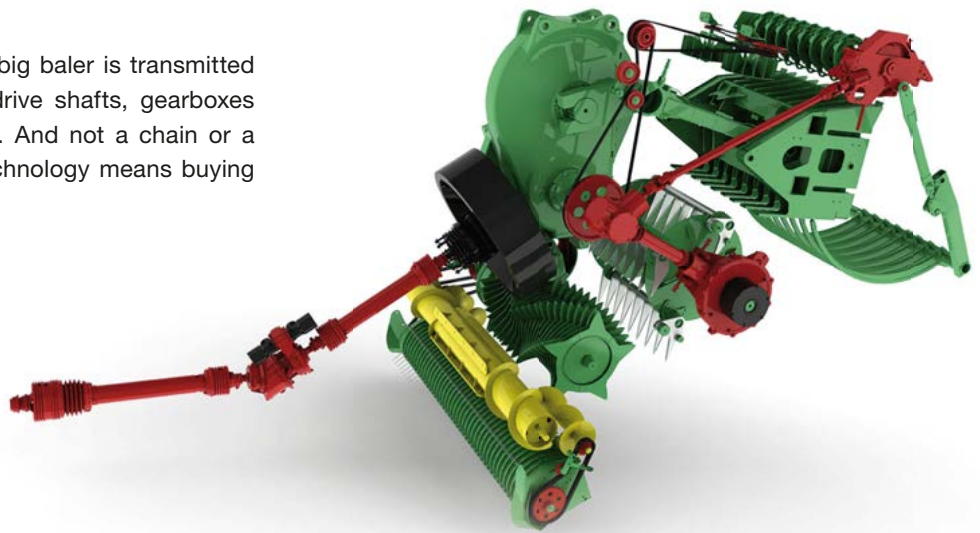

Smooth start

For a smooth machine start, all BiG Pack HDP II models are equipped with a hydraulic start assist system consisting of two hydro motors that accelerate the flywheel before the tractor pto is engaged. The intermediate gearbox on the drawbar has two advantages: it reduces wear on the straight drive shaft and boosts the pto speed – a clever solution that helps maximize the flywheel's inertia.



BiG Pack HDP II

The new dimension of baling



The separate driveline

The pick-up and the rotor cutter on the BiG Pack HDP II with XCut are powered by a separate 4-groove poly belt which shuts off automatically if there is a blockage inside the machine. To save power, the pick-up and rotor start off only after the plunger has started.



Full throttle

The pick-up on the packer machines is powered directly via the main gearbox and drive shaft which has an integrated cam clutch to protect the pick-up from overload.



A massive rotor for even higher throughputs

The 30% bigger rotor cutter features five rows of tines for highest throughputs. These V-shaped tines pull the crop through the blades with a minimum of input power and keep the bale chamber consistently filled up to the sides.



Eight double knotters

Extremely high-density, stable bales produced at very high ground speeds – that’s a challenge for any twine and knotter, especially when the crop is prone to expanding. So KRONE has got together with Raspe to develop a brand new, patented knotter system especially for the BiG Pack HDP II. This system comprises eight slim double knotters which expose the individual strings to minimal pull, enabling them to hold even denser packs.

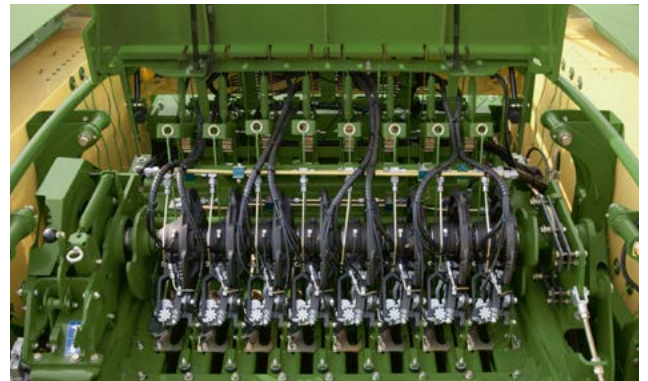

Deselectable pusher dogs

A pin sets the system, either enabling all pusher dogs to clear the entire bale chamber or disabling the dogs at the front so that just the finished bale is unloaded.

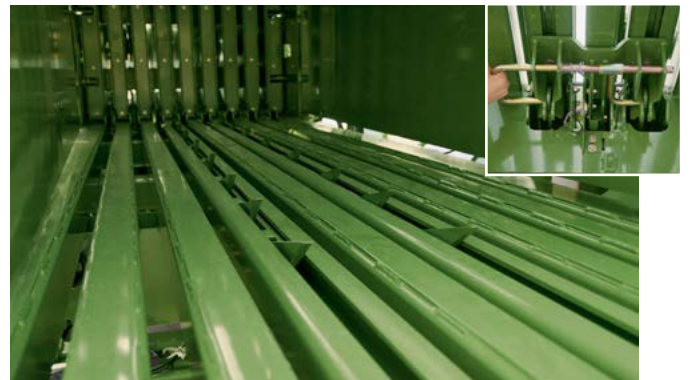

54 balls of twine on board

27 balls of twine – plenty for long working days. The twine boxes can be folded down hydraulically and conveniently from the cab for easy refilling and access to service points. Fitted with LED lights for greater convenience during night-time work.





The KRONE **BaleCollect** accumulator

- Saves time and money in big bale logistics
- Telescoping drawbar for optimum on-road handling
- Choice of unloading modes for subsequent work steps
- Standard and integral weighing system
- Efficient and gentle on the soil

Running behind the baler, the KRONE BaleCollect collects up to three square bales from a 120 cm wide chamber or up to five bales from an 80 cm chamber. And has a choice of unloading modes to prepare the bales for the next steps in the field, significantly shortening post-baling loading times, reducing journeys and minimizing soil compaction.



How it works

The BaleCollect platform can store up to three bales that leave a 120 cm chamber or up to five bales from an 80 cm chamber. When a bale leaves the chamber it is pushed to the right or left side by a bar, clearing the way for the next bale to enter the platform. All bales are automatically pushed off the platform according to the unloading mode selected by the operator.

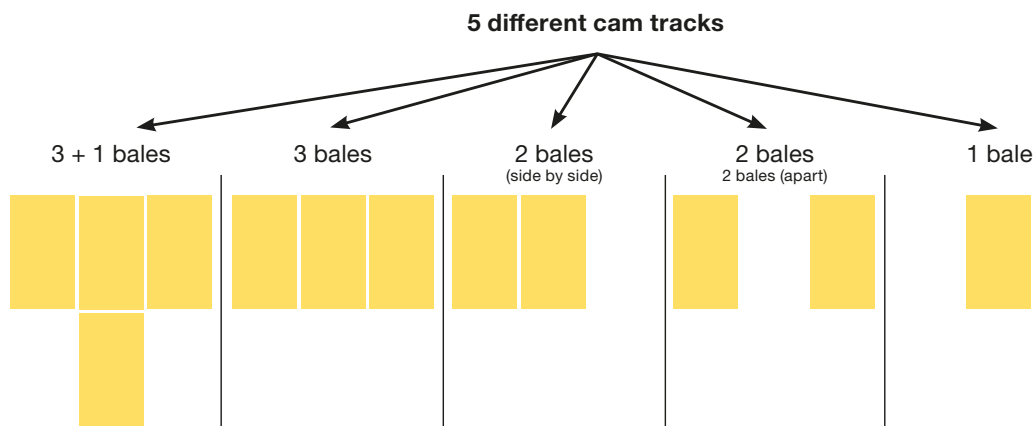

Depositing the bales to needs

Depending on the individual harvest and process chain, customers may want to have their bales deposited in specific patterns. BaleCollect offers five different unloading modes for 120 cm wide bales. The “3 bales” or “3+1 bales” modes are used to deposit all bales on or near the headland. By comparison, silage bales will be deposited to the “2 bales side by side” mode or the “2 bales apart” mode. These strategies are selected in harvest chains where the following wrapper is wrapping two silage bales into one pack or even picks up the bales itself. Of course, the operator can also push off the bales manually at any time by pressing a button.



Clever stuff

The bale accumulator is attached to the baler to collect the bales as they leave the baling chamber. To ensure safety on the road, KRONE has come up with an innovative attachment via the telescoping drawbar.



New from KRONE



Conventional design

Safe road travel

For road transport, the platform folds into a compact unit of less than 3 m, the drawbar extends and the castering wheels/axles are made rigid. This allows BaleCollect to track reliably behind the baler – for safe rides at high speeds of up to 50km/h and through narrow gates.



Options

The right kit for every job

- Fully integrated moisture sensor in the baling chamber
- Fully integrated weighing system in the bale chute
- Camera system for safe reversing
- Extra twine boxes at the rear

For even greater convenience and effectiveness, choose from a number of options that add even more features to your machine, including moisture sensing and bale weighing systems that give accurate information on the job at hand, or LED work lights and reverse cameras for unobstructed vision and a clear all-round view.



Clear crop quality display

The optional moisture sensor updates the operator on the current crop condition, displaying the information on the monitor in the cab. The information is read out on a cab-based monitor. An alarm is issued automatically whenever a preset parameter is exceeded.



Precise weight

Would you like to keep track of whether the bale weight is meeting your customers' needs? Then the optional bale chute with integrated weighing system is just the right technology for you. The terminal displays not just the weight of every single bale but also the total weight of the finished baling job.



Clear view to all sides

You can opt for a reverse-drive CCTV system that comprises a camera and a colour screen which has a second port for a second camera. The camera can also connect to the CCI terminal.



Turn night into day

The three optional LED work lights illuminate the area behind the baler and the pick-up at the front. Simply connect the lights to the existing harness and switch them from the terminal. Enjoy optimum visibility during those night shifts.



Smooth start

All KRONE big balers feature a hydraulic start assist system. A hydromotor gets the flywheel up to speed before the tractor pto is engaged – all operated conveniently via the terminal in the cab, naturally.



Standing firm

To enable the machines to be attached and removed even more easily, KRONE offers an optional hydraulic stand for all machines in the BiG Pack 870, 890, 1270 and 1290 series (standard spec with the BiG Pack 1290 HDP, HDP II, 4 x 4 and machines with PreChop).



Options

Further options for more operator comfort



More twine on board

To supplement the main twine boxes, two extra twine boxes can be mounted at the rear of the machine, allowing you to securely carry either 12 balls of twine or 10 balls of twine and one toolbox (not available in combination with the BaleCollect.)



Cutting edge

All BiG Pack machines with the XCut or VariCut cutting system and PreChop can be fitted with an extra set of blades as an option.



High-pressure cleaning fan

As a standard specification, the BiG Pack 1270, 1290 and 1290 HDP can have a pneumatic knotter cleaning system which can be boosted with a mechanical constant flow fan. The continuous air flow keeps the knotters free from debris before it has a chance to accumulate.



Hitch for quiet running

Farmers in different countries use different attachment systems: A top- and bottom-mount drawbar is a standard feature on all BiG Packs. A ball- or ring-hitch drawbar is an option for all BiG Packs. Choose between the ball hitch and ring hitch for use with the pivoting drawbar.



CCI.Control Mobile: recording your process data

Data and order management with CCI.Control Mobile: machine, fleet management and navigation data can be recorded on this iPad app.

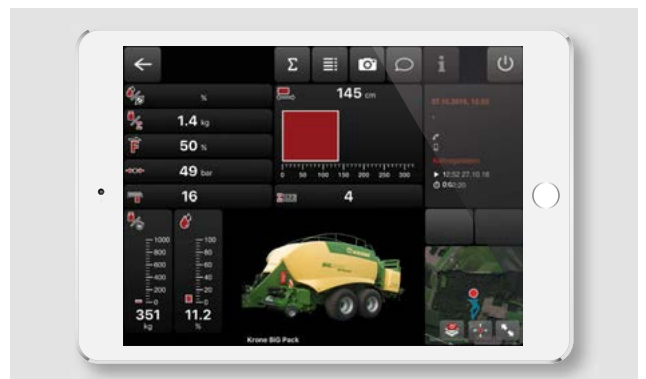

Data management with BiG Data Tools

BiG Data Tools is KRONE's easy-to-use, free analysis software. It displays machine data recorded via CCI.Control Mobile in the form of a bale map.

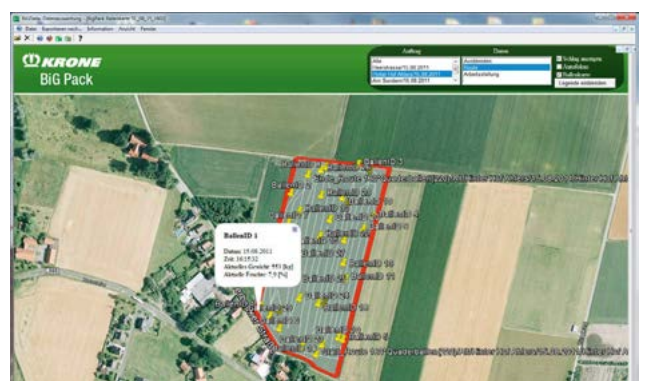



KRONE excellent twine

- This twine has been developed and optimized to the specifications of the KRONE BiG Pack baler and the system.
- Greatest knot strength, superior to regular twines of an average 220 kgf tear resistance
- Optimum fibrilling ensures effective knotting

		MultiBale (Smart) ²	HDP Smart ²	HDP Strong ²	HDP X-treme ²	
		Knot- ters	Regular bale density	High bale density	Very high bale density	Extremely high bale density
BiG Pack 870 HDP 80 x 70 cm (2'7.5" x 2'4")		5				
BiG Pack 890 80 x 90 cm (2'7.5" x 2'11")		4				
BiG Pack 1270 120 x 70 cm (3'11" x 2'4")		6				
BiG Pack 1290 120 x 90 cm (3'11" x 2'11")		6				
BiG Pack 1290 HDP 120 x 90 cm (3'11" x 2'11")		6				
BiG Pack 1290 HDP II 120 x 90 cm (3'11" x 2'11")		8				
BiG Pack 4x4 120 x 130 cm (3'11" x 4'3")		6				



KRONE excellent MultiBale (Smart)²





MultiBale² is a new KRONE twine which offers an approximately 28% longer roll length than MultiBale and yet the same level of knot strength.

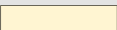
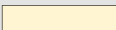
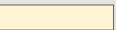

KRONE excellent HDP Strong²

This twine is recommended when baling extremely dense bales and in difficult harvest conditions. HDP Strong² offers added strength and longer roll lengths over the HDP Strong twine, delivering the traditional KRONE quality to users with extra high requirements.



Twine		MultiBale Smart ²	MultiBale	MultiBale	HDP Smart ²	HDP Strong ²	HDP X-treme ²
Double pack order no.		27 023 342 0	927 943 0	923 944 0	27 023 343 0	27 023 217 0	27 023 218 0
kg/roll		11	10	11	11	11	11
Max. knot strength	kgf	245	245	245	280	315	335
Max. tear resistance	kgf	380	350	380	460	510	550
Colour							



KRONE excellent HDP Smart²

The use of the correct twine is critical when tying high-density bales. The KRONE excellent Twine HDP Smart² was specifically developed for high-density big balers. The new twine goes through the knotter and the twine guides experiencing only minimum wear. HDP Smart² offers added roll length over the traditional HDP Smart twine whilst retaining the high knot strength.



KRONE excellent HDP X-treme²

This twine is the power package in the KRONE twine family. Offering an enormous resistance to tearing and great knot strength, this is the twine of choice for baling highest-density bales. Withstanding the harshest harvest conditions such as exposure to high UV radiation, HDP X-treme² keeps even the heaviest bales in firm shape.



Technical data

The BiG Pack standard programme

		BiG Pack 890 HighSpeed	BiG Pack 890 XC HighSpeed	BiG Pack 1270 HighSpeed	BiG Pack 1270 XC HighSpeed
Chamber width x height	cm	80x90 (2'7.5" x 2'11")	80x90 (2'7.5" x 2'11")	120x70 (3'11" x 2'4")	120x70 (3'11" x 2'4")
Bale length	m	1.0-2.7 (3'3" - 8'10")	1.0-2.7 (3'3" - 8'10")	1.0-2.7 (3'3" - 8'10")	1.0-2.7 (3'3" - 8'10")
Tractor power	Min. kW/hp	80 / 109	95 / 129	85 / 116	100 / 136
Pick-up work width DIN	m	1.95 / 2.35 (6'5"/7'8.5")	1.95 / 2.35 (6'5"/7'8.5")	2.35 (7'8.5")	2.35 (7'8.5")
Length in transport position	m	7.95 (26'1")	7.95 (26'1")	7.95 (26'1")	7.95 (26'1")
Length in working position	Approx. m	9.18 (30'1")	9.18 (30'1")	9.18 (30'1")	9.18 (30'1")
Height	m	3.14 (10'4")	3.14 (10'4")	2.94 (9'8")	2.94 (9'8")
Width	mm	2.59* / 2.99 (8'6"/9'10")	2.59* / 2.99 (8'6"/9'10")	2.99 (9'10")	2.99 (9'10")
Min weight**	approx. t	7.8	8.8	8.4	9.4
Tyres for the 40 km/h single axle		710 / 45 - 22.5 171 A8	710 / 45 - 22.5 171 A8	710 / 45 - 22.5 171 A8	710 / 45 - 22.5 171 A8
Tyres for 60 km/h tandem axles		500 / 50 - 17 14 PR 550 / 45 - 22.5 16 PR 560 / 45 R 22.5 146 D 620 / 40 R 22.5 148 D -	500 / 50 - 17 14 PR 550 / 45 - 22.5 16 PR 560 / 45 R 22.5 146 D 620 / 40 R 22.5 148 D -	500 / 50 - 17 14 PR 550 / 45 - 22.5 16 PR 560 / 45 R 22.5 146 D 620 / 40 R 22.5 148 D -	500 / 50 - 17 14 PR 550 / 45 - 22.5 16 PR 560 / 45 R 22.5 146 D 620 / 40 R 22.5 148 D 620 / 50 R 22.5 154 D
Brakes		Air/hydr.	Air/hydr.	Air/hydr.	Air/hydr.
Twine storage**	No. of rolls	32	32	32	32
PreChop		-	-	-	Optional
Single knotter		-	-	6 series	6 series
Double knotter		4 series	4 series	6 option	6 option
MultiBale		-	-	Optional	Optional
Max. no. of blades		-	16	-	26
Min. cutting length	mm	-	44 (2")	-	44 (2")
Plunger strokes	no. of strokes/minute	49	49	45	45
BaleCollect		Optional	Optional	Optional	Optional

All specifications, weights and dimensions do not necessarily comply with standard specifications and are therefore not binding. Specifications are subject to change without notice.

* For standard pick-up and depending on tyres

** Varies according to machine specification

*** Including the optional twine boxes (+ 12 balls)



BiG Pack 1270 VC HighSpeed	BiG Pack 1290 HighSpeed	BiG Pack 1290 XC HighSpeed	BiG Pack 4 x 4 HighSpeed	BiG Pack 4 x 4 XC HighSpeed
120x70 (3'11" x 2'4")	120x90 (3'11" x 2'11")	120x90 (3'11" x 2'11")	120x130 (3'11" x 4'3")	120x130 (3'11" x 4'3")
1.0-2.7 (3'3" - 8'10")	1.0-2.7 (3'3" - 8'10")	1.0-2.7 (3'3" - 8'10")	1.0-3.2 (3'3" x 10'6")	1.0-3.2 (3'3" x 10'6")
135 / 184	90 / 122	105 / 143	130 / 177	145 / 197
2.35 (7'8.5")	2.35 (7'8.5")	2.35 (7'8.5")	2.35 (7'8.5")	2.35 (7'8.5")
7.95 (26'1")	7.95 (26'1")	7.95 (26'1")	9.15 (30')	9.15 (30')
9.18 (30'1")	9.18 (30'1")	9.18 (30'1")	10.85 (35'7")	10.85 (35'7")
2.94 (9'8")	3.14 (10'4")	3.14 (10'4")	3.56 (11'8")	3.56 (11'8")
2.99 (9'10")	2.99 (9'10")	2.99 (9'10")	2.99 (9'10")	2.99 (9'10")
10.1	8.9	9.9	13.1	13.8
–	710 / 45- 22.5 171 A8	710 / 45- 22.5 171 A8	–	–
–	500 / 50- 17 14 PR	500 / 50- 17 14 PR	550 / 45 22.5 20 PR	550 / 45 22.5 20 PR
–	550 / 45 - 22.5 16 PR	550 / 45 - 22.5 16 PR	560 / 45 R 22.5 146 D	560 / 45 R 22.5 146 D
560 / 45 R 22.5 146 D	560 / 45 R 22.5 146 D	560 / 45 R 22.5 146 D	620 / 50 R 22.5 154 D	620 / 50 R 22.5 154 D
620 / 40 R 22.5 148 D	620 / 40 R 22.5 148 D	620 / 40 R 22.5 148 D	620 / 55 R 26.5 166 D	620 / 55 R 26.5 166 D
620 / 50 R 22.5 154 D	–	620 / 50 R 22.5 154 D	710 / 50 R 26.5 170 D	710 / 50 R 26.5 170 D
Air/hydr.	Air/hydr.	Air/hydr.	Air/hydr.	Air/hydr.
32	32	32	32	32
Optional	–	Optional	–	–
6 series	–	–	–	–
6 option	6 series	6 series	6 series	6 series
Optional	–	–	–	–
51	–	26	–	26
22 (1")	–	44 (2")	–	44 (2")
45	45	45	38	38
Optional	Optional	Optional	Optional	Optional



Technical data

The BiG Pack HDP programme

		BiG Pack 870 HDP HighSpeed	BiG Pack 870 HDP XC HighSpeed	BiG Pack 1290 HDP HighSpeed
Chamber width x height	cm	80 x 70 (2'7.5" x 2'4")	80 x 70 (2'7.5" x 2'4")	120x90 (3'11" x 2'11")
Bale length	m	0.5 - 2.7 (1'8" - 8'10")	0.5 - 2.7 (1'8" - 8'10")	1.0 - 3.2 (3'4" - 10'6")
Tractor power	Min. kW/hp	105 / 143	120 / 163	130 / 177
Pick-up work width DIN	m	1.95 / 2.35 (6'5"/7'8.5")	1.95 / 2.35 (6'5"/7'8.5")	2.35 (7'8.5")
Length in transport position	m	7.95 (26'1")	7.95 (26'1")	8.75 (28'8.5")
Length in working position	Approx. m	9.18 (30'1")	9.18 (30'1")	9.40 (30'10")
Height	m	2.96 (9'8.5")	2.96 (9'8.5")	3.14 (10'4")
Width	m	2.59* / 2.99 (8'6"/9'10")	2.59* / 2.99 (8'6"/9'10")	2.99 (9'10")
Min weight**	approx. t	9.0	9.4	12.0
Tyres for the 40 km/h single axle		–	–	–
Tyres for 50-60 km/h tandem axles		500 / 50 - 17 14 PR 550 / 45 - 22.5 16 PR – 560 / 45 R 22.5 146 D 620 / 40 R 22.5 148 D	500 / 50 - 17 14 PR 550 / 45 - 22.5 16 PR – 560 / 45 R 22.5 146 D 620 / 40 R 22.5 148 D	– 550 / 45 - 22.5 20 PR – 560 / 45 R 22.5 146 D 620 / 40 R 22.5 148 D
Brakes		Air/hydr.	Air/hydr.	Air/hydr.
Twine storage**	No. of rolls	32	32	32
PreChop		–	–	–
Single knotter		–	–	–
Double knotter		5 series	5 series	6 series
MultiBale		Standard	Standard	–
Max. no. of blades		–	16	–
Min. cutting length	mm	–	44 (2")	–
Plunger strokes	no. of strokes/minute	49	49	45
BaleCollect		Optional	Optional	Optional

All specifications, weights and dimensions do not necessarily comply with standard specifications and are therefore not binding. Specifications are subject to change without notice.

* For standard pick-up and depending on tyres

** Varies according to machine specification

*** Including the optional twine boxes (+ 12 balls)



BiG Pack 1290 HDP XC HighSpeed	BiG Pack 1290 HDP VC HighSpeed	BiG Pack 1290 HDP II	BiG Pack 1290 HDP II XC
120x90 (3'11" x 2'11")	120x90 (3'11" x 2'11")	120x90 (3'11" x 2'11")	120x90 (3'11" x 2'11")
1.0-3.2 (3'4" - 10'6")	1.0-3.2 (3'4" - 10'6")	1.0-3.2 (3'4" - 10'6")	1.0-3.2 (3'4" - 10'6")
145 / 197	180 / 245	170 / 231	190 / 258
2.35 (7'8.5")	2.35 (7'8.5")	2.35 (7'8.5")	2.35 (7'8.5")
8.75 (28'8.5")	8.75 (28'8.5")	9.13 (29'11")	9.13 (29'11")
9.40 (30'10")	9.40 (30'10")	10.80 (35'5")	10.80 (35'5")
3.14 (10'4")	3.14 (10'4")	3.71 (12'2")	3.81 (12'6")
2.99 (9'10")	2.99 (9'10")	2.99 (9'10")	2.99 (9'10")
12.6	13.0	14.2	15.400
–	–	–	–
–	–	560 / 45 R 22.5 146 D	560 / 45 R 22.5 146 D
550 / 45 - 22.5 20 PR	–	620 / 50 R 22.5 154 D	620 / 50 R 22.5 154 D
–	–	620 / 50 R 22.5 161 D	–
560 / 45 R 22.5 146 D	560 / 45 R 22.5 146 D	620 / 55 R 26.5 166 D	620 / 55 R 26.5 166 D
620 / 50 R 22.5 154 D	620 / 50 R 22.5 154 D	710 / 50 R 26.5 170 D	710 / 50 R 26.5 170 D
Air/hydr.	Air/hydr.	Air/hydr.	Air/hydr.
32	32	54	54
Optional	–	–	–
–	–	–	–
6 series	6 series	8 series	8 series
–	–	–	–
26	51	–	26
44 (2")	22 (1")	–	44 (2")
45	45	45	45
Optional	Optional	Optional	Optional

Maschinenfabrik Bernard KRONE

Perfect in every detail

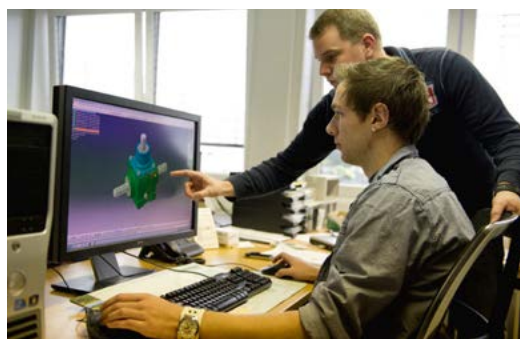

Innovative, proficient and close to our customers – these are the keywords that mark the philosophy of our family-owned company. As a forage specialist, KRONE manufactures disc mowers, tedders, rakes, forage wagons and silage trailers, round and square balers as well as the high-capacity and self-propelled BiG M mower conditioners and our BiG X forage harvesters. Quality made in Spelle – since 1906.

Your KRONE dealer



Maschinenfabrik Bernard KRONE GmbH & Co. KG

Heinrich-Krone-Straße 10
D-48480 Spelle

Phone: +49 (0) 5977 935-0
Fax: +49 (0) 5977 935-339

info.ldm@krone.de | www.krone.de